

IP PTZ CAMERA

USER GUIDE

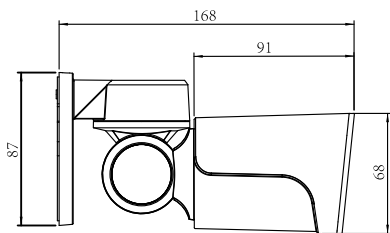

TYPE A:



wall mount

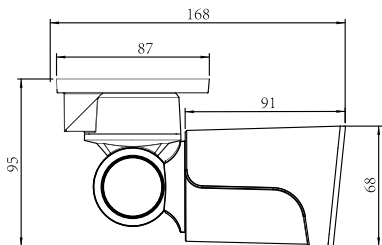

ceiling mount

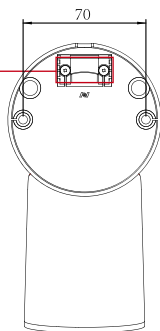

To switch the mount style, remove the two screws on the pan bottom and rotate 180 degree to remount.

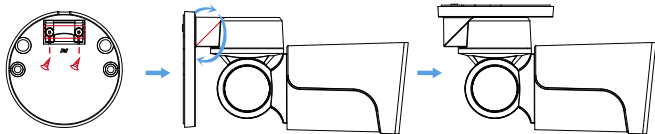

This Mini PTZ cylinder camera can support both wall mount and ceiling mount.
Pan: 0° ~ 180° Tilt: 0° ~ 55°, with Guard Position function.

TYPE B:

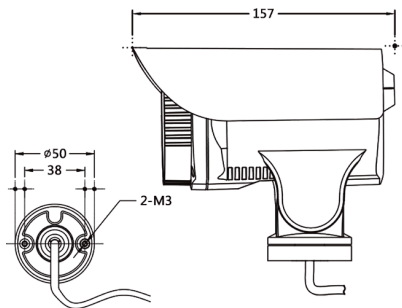
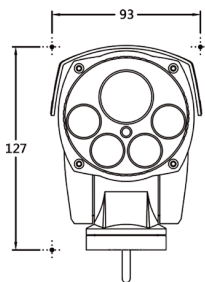

This Mini PTZ camera only supports wall mount. Pan: 0° ~ 300°Tilt: -5° ~ 60°, support Guard Position.

TYPE C: (2.5 inch)

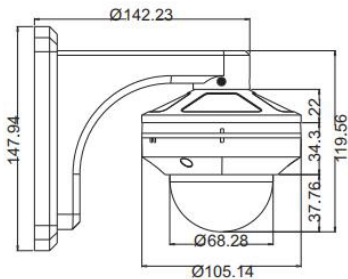
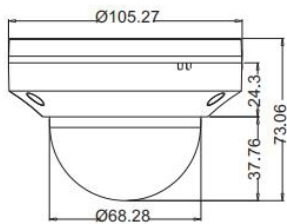

TYPE D: (4.5 inch)

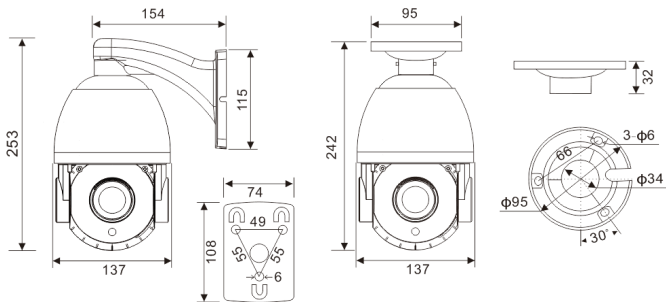

TYPE E: (4.5 inch)

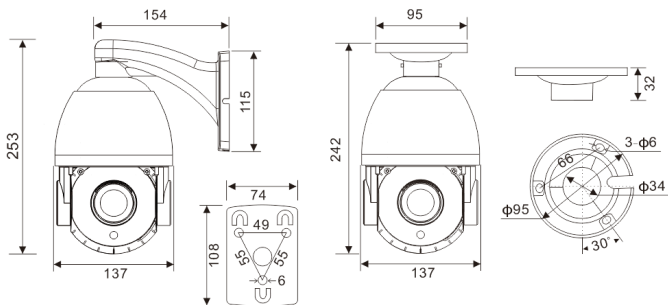

TYPE F: (6 inch)

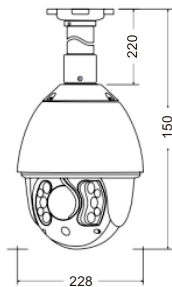
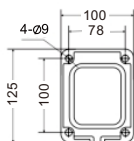
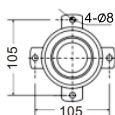
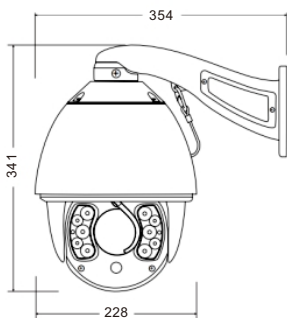

TYPE G: (7 inch)

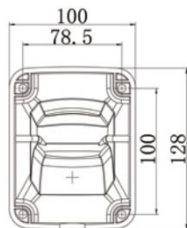
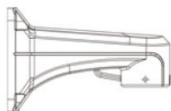
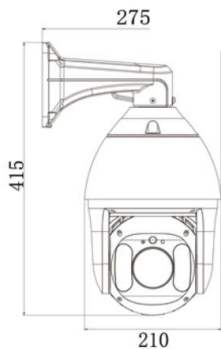

Note: This manual may contain some incorrect information, even though it was published with our carefully proofreading. The new updates will be added to the next release without notice. Your valuable advice is really appreciated.

TYPE H: (5 inch)

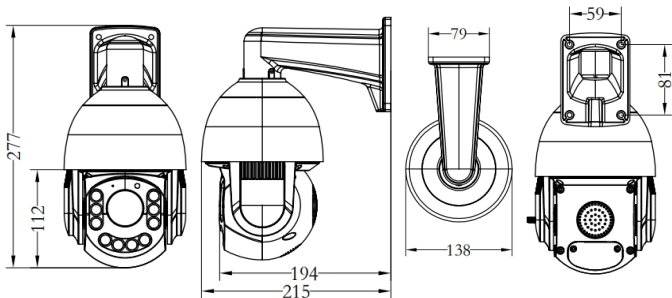

TYPE I: (2inch)

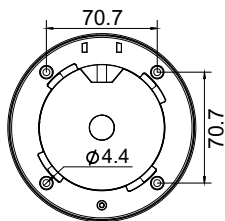
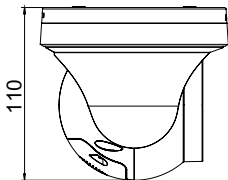
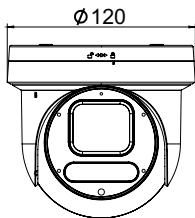

Installation Guide

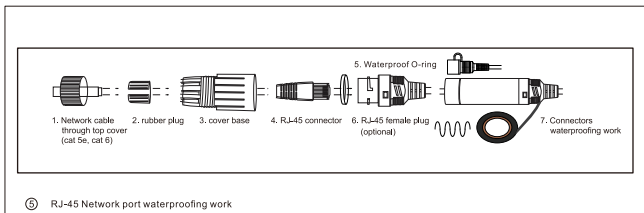
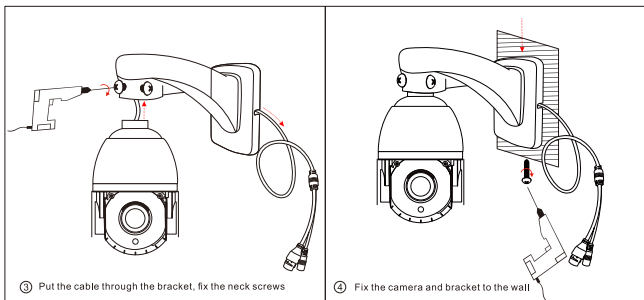
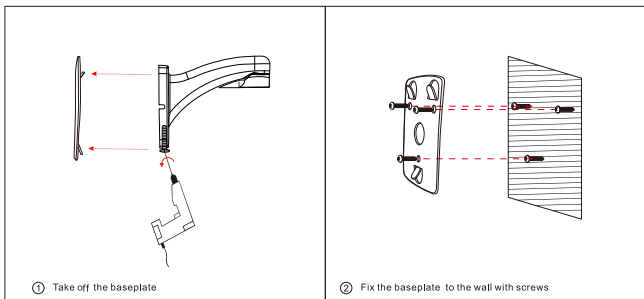

1

Connecting the camera to system

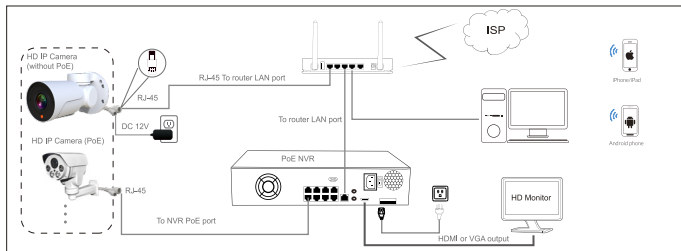

Figure 1: Working With POE NVR

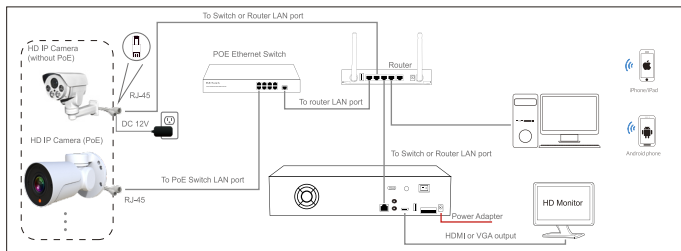

Figure 2: Working With POE Switch

Note:

1. The camera should be connected to an OPTIONAL 12 volt power supply if you do not use PoE (Power over Ethernet).
2. There are two kinds of zoom lens 2.8-12mm and 5-50mm optional. Please choose 5-50mm zoom lens for long distance video surveillance .

2

Modifying the camera's IP address

Default: DHCP IP address: 192.168.0.123 , Username: admin, Password: 123456

(We strongly recommend modifying the default password for your security).

Each IP camera has the same default IP address after leaving the factory. In order to guarantee network connectivity and access the live video, it is essential to change the camera's IP address to unique via computer before using.

Before modifying the IP address you'd better confirm the IP network planning and avoid IP address conflict.

Steps on Local Area Windows 10 PC : **Search Windows -> cmd -> ipconfig /all**

```
C:\Users\Administrator>ipconfig /all

Windows IP Configuration

Host Name . . . . . : Tony-testWin10
Primary Dns Suffix . . . . . :
Node Type . . . . . : Hybrid
IP Routing Enabled. . . . . : No
WINS Proxy Enabled. . . . . : No

Ethernet adapter Local Area Connection:

Connection-specific DNS Suffix . . :
Description . . . . . : Realtek PCIe GBE Family Controller
Physical Address. . . . . : 49-61-86-0C-5F-95
DHCP Enabled. . . . . : Yes
Autoconfiguration Enabled . . . . : Yes
Link-local IPv6 Address . . . . . : fe80::b525:234:58d4:98f3%10(Preferred)
IPv4 Address. . . . . : 192.168.1.158(Preferred)
Subnet Mask . . . . . : 255.255.255.0
Lease Obtained. . . . . : Saturday, October 21, 2017 10:15:08 AM
Lease Expires . . . . . : Saturday, October 21, 2017 12:15:08 PM
Default Gateway . . . . . : 192.168.1.1
DHCP Server . . . . . : 192.168.1.1
DHCPv6 IAID . . . . . : 138436998
DHCPv6 Client GUID . . . . . : 00-01-00-01-20-DE-A3-49-40-61-86-0C-5F-95
DNS Servers . . . . . : 192.168.1.1
                        192.168.1.1
NetBIOS over Tcpip. . . . . : Enabled
```

Now you can get all the local network information.

IPv4 Address: 192.168.1.?
Subnet Mask: 255.255.255.0
Default gateway: 192.168.1.1
DNS Servers: 192.168.1.1

Note : you can also find out the LAN configuration via Windows GUI

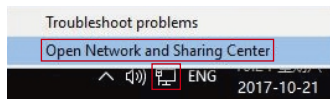

2

Modifying the camera's IP address

Right-click on the Network icon and select **open Network and Sharing Center**.

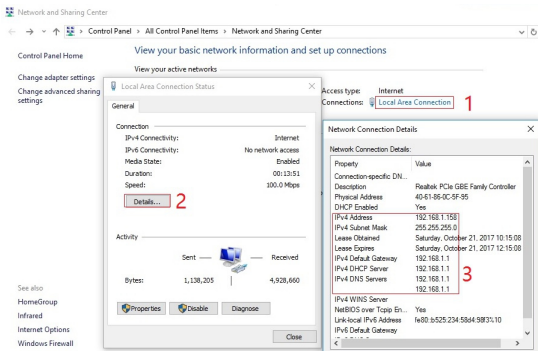

If the camera is installed to work with the local switch or router directly, the camera IP range should be 192.168.1.x (x=2-254). To void IP conflict, you should test and select an unoccupied IP like this:

Command Prompt ping test

```
Command Prompt

C:\Users\Administrator>ping 192.168.1.123

Pinging 192.168.1.123 with 32 bytes of data:
Reply from 192.168.1.158: Destination host unreachable.
Reply from 192.168.1.1: Destination host unreachable.
Reply from 192.168.1.1: Destination host unreachable.
Reply from 192.168.1.1: Destination host unreachable.

Ping statistics for 192.168.1.123:
    Packets: Sent = 4, Received = 4, Lost = 0 (0% loss),

C:\Users\Administrator>ping 192.168.1.41

Pinging 192.168.1.41 with 32 bytes of data:
Reply from 192.168.1.41: bytes=32 time=1ms TTL=64
Reply from 192.168.1.41: bytes=32 time<1ms TTL=64
Reply from 192.168.1.41: bytes=32 time<1ms TTL=64
Reply from 192.168.1.41: bytes=32 time=1ms TTL=64

Ping statistics for 192.168.1.41:
    Packets: Sent = 4, Received = 4, Lost = 0 (0% loss),
    Approximate round trip times in milli-seconds:
        Minimum = 0ms, Maximum = 1ms, Average = 0ms

C:\Users\Administrator>
```

Only when reply unreachable that means the IP address is no conflict and available, otherwise when you see time reply do not use this IP address.

There are three methods to modify the camera IP configuration, Search tool, PC Client software and Internet Explorer.



IP camera search tools V5.0.4_20200107

All Start Search Export to Excel admin 123456 QR Automatic printing Total: 2 Selected: 2

IP Address	HTTP ...	Model	Title Name	Preview	Firmware Version	Status	All subn...
<input checked="" type="checkbox"/> 192.168.16.100	80	IM500F	Camera		IM500F_AF_VO_BU_Y_ER-R1M-HE_L_V3.0.2.3 b...	Login success	close
<input checked="" type="checkbox"/> 192.168.16.161	80	IM500	Camera		IM500_AF_VO_BH_Y_BH-MS_L_V3.0.2.1 build 2...	14:59:53 Alarm-motion detect disappear	close

IP address setting

DHCP

Start IP: 192.168.1.60

End IP: 192.168.1.61

Netmask: 255.255.255.0

Gateway: 192.168.1.1

DNS1: 192.168.1.1

DNS2: 8.8.8.8

IP address Checked OK.

OK Cancel

Batch Reset Batch Reboot IP Batch Setting 500K/60HZ Batch Set Language Batch Sync Time Batch Set Password

Upgrade Firmware C:\Users\Administrator\Desktop\Firmware\IM500L_VO_AF-R1M-MS_L_V3.0.2.1_Y_BH_IM500L_VO_202006241 Browse ...

DHCP
IP Batch Manual Setting

Click **Start Search** and all your cameras in the LAN will be listed. Modify IP address to suit the LAN's IP scheme.

- 1) Click the **ALL** check-box then click "IP Batch Manual Setting".
- 2) Click **Check** to verify IP address configuration and click **OK** to save. it's user-friendly that the search tool can read the computer Network IP address and calculate the camera quantity to match the range of Start IP and End IP.

Tips:

Reset Password -> **Restore default settings;**

Video Preview -> Click **Preview** buttons;

Firmware upgrade -> Select the check-box, click **Browse** then click **Upgrade Firmware**.

4

Using the LMS client software for Windows PC

(Default user name: admin, Password: 123456)

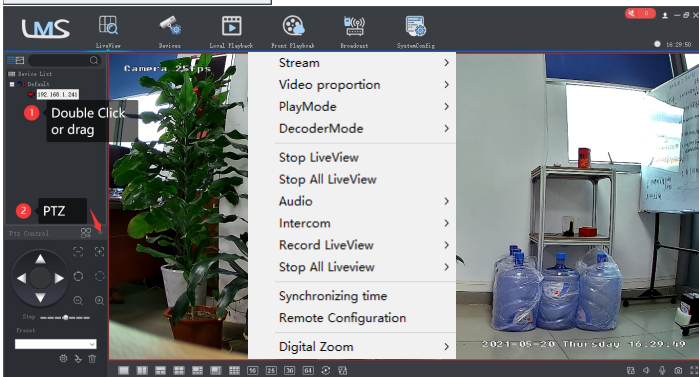
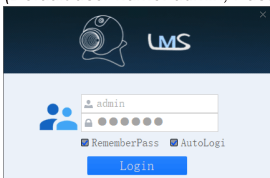

Go to the Devices Config and click Start search, all the camera in the LAN will be listed.

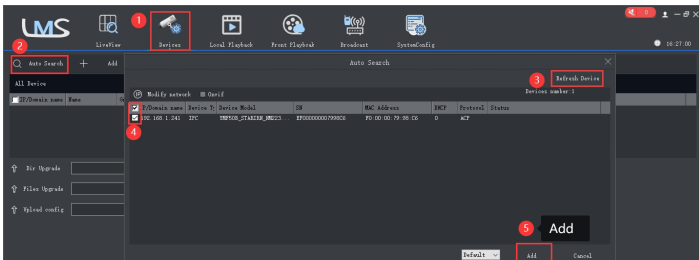

5

Working with Internet Explorer

To access the camera's web interface, type in the IP camera's IP address in Internet Explorer's URL bar to gain access to the login page. Please modify IP address to the same subnet if login page can not load.

(Default user name: *admin*, Password: *123456*)

Edge, Chrome, Firefox, Safari will work via HTML5 without active-x plugin

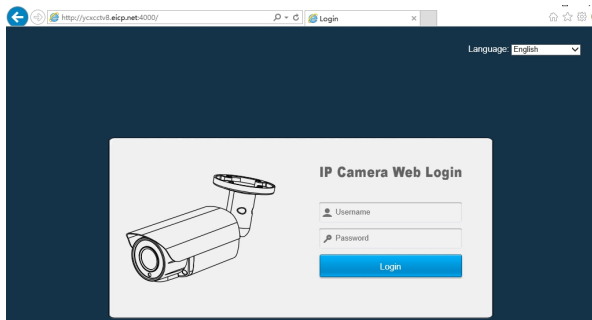

From the login page, select your familiar language, then log in with the username and password.

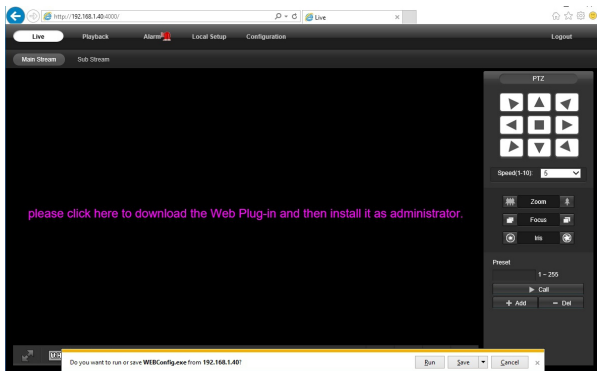

Install **Web Plug-in** when red line characters prompted. You may have to download **WEBConfig.exe** and run it as administrator.

After installation, restart or refresh your web browser and access the IP again. The live video will start automatically after login successfully.

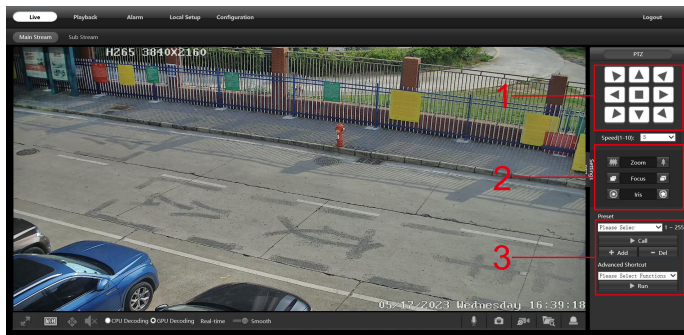

- 1. Rotation direction control** – Left/Right horizontal rotation angle is up to 180°. Up/Down vertical rotation angle can reach to 55°. Rotation speed can be adjusted.
- 2. Motorized zoom lens control** – camera can do optical **Zoom In** and **Zoom Out**.
- 3. Preset** -- to remember a position, input a number and click **Add**. Then you can directly go back via call the number. Delete a preset: input a number and click **Del** (Type A camera only supports one preset point)
- 4. Guard Position** – 1)remember preset 1: move the camera to an import position then **add** to **preset 1** ; 2)enable Guard Position: **Add** preset 76 ->**Call** preset 1; 3)disable Guard Position: **Add** preset 76 ->**Call** preset 2. (TypeA ,Type B and Type I)
- For more advanced functions , go to Appendix 1 for command list. Keeping pressing on live video and dragging for **Digital Zoom**. If there is a delay in video response when accessing remotely, please switch to Sub Stream instead. To learn the function of each button, just put the mouse on, it will show screen tips.

6

General Configurations

1) Power System frequency configuration (50Hz/60Hz)

➤ Configuration > Camera > Image > Power Frequency

To avoid the video flicker, the camera should be set to right working frequency to suit the country electric system. The countries that use 60Hz have USA, Canada, Japan, Korea, Taiwan, Brazil, Philippines, Mexico. Other countries apply 50Hz.

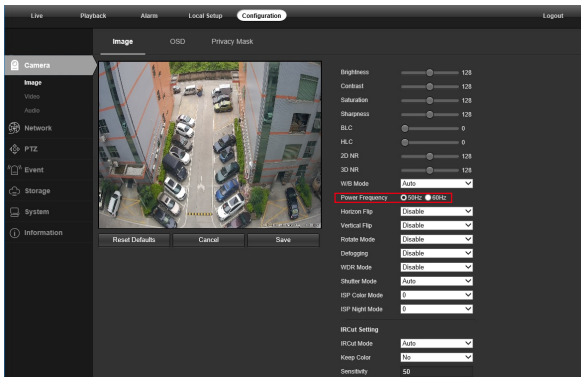

2) To modify the camera Title name and Time & Date

➤ Configuration > Camera > Image > OSD > Title Message

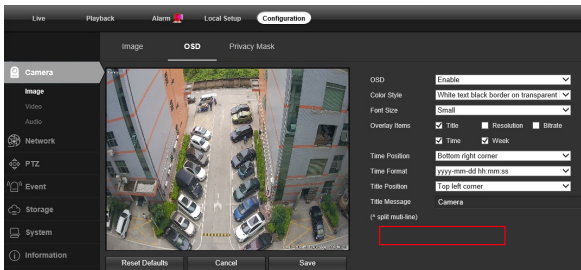

➤ Configuration > System > Time setup

There are two time update modes available, **Manual** and **NTP**.

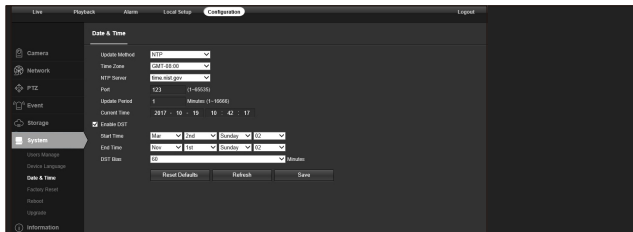

- Select your Time Zone, and click PC Sync. Set up your DST (Daylight Savings Time) if needed, click Save. (Time and date will reset to 2000-01-01 if camera restarts)
 - If the camera is connected to the Internet, you can set up a NTP server for the camera to sync the time and date automatically.
- 3) To enable Motion Detection Alarm

➤ Configuration > Event > Video Detection

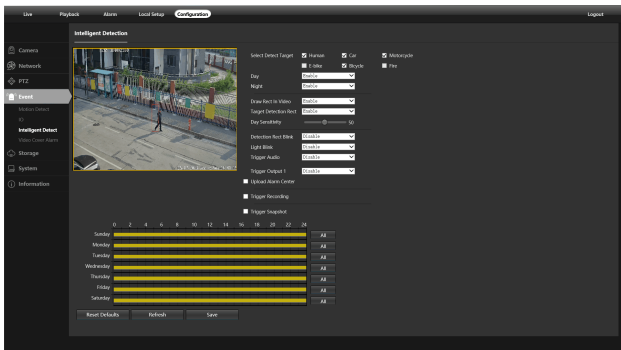

When Motion is detected, there is a small alarm light pup up beside the Alarm menu. You can also setup an email address or FTP storage server to receive the motion snapshot. (Trigger recording will work only if memory card or NFS NAS connected.)

Search and download "**VideoLink**" in Apple App Store or Google Play Store.



iPhone



Android

1. Register an new account
2. Select your country or region

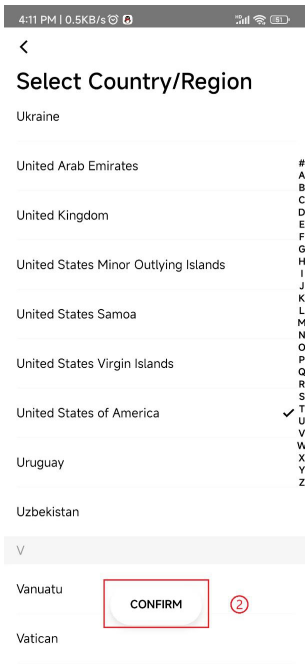
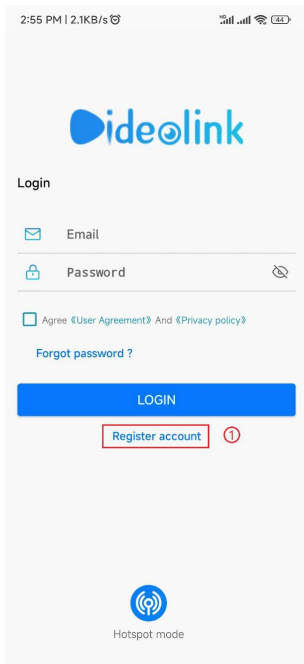

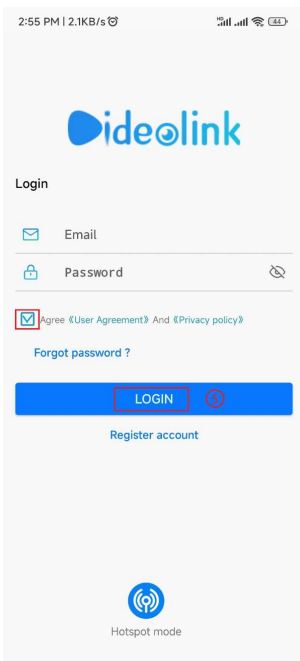
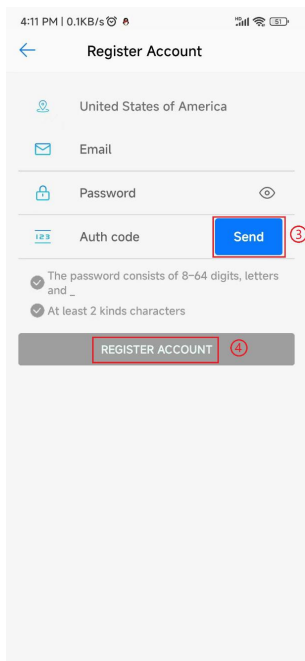

3. Input your email address and setup a password, tap **Send** to get the code by email, tap **REGISTER ACCOUNT** to finish registration.
4. Login with the email and password registered in previous step.
5. Visit camera web interface, enable P2P function. After a while it will show the QR code.

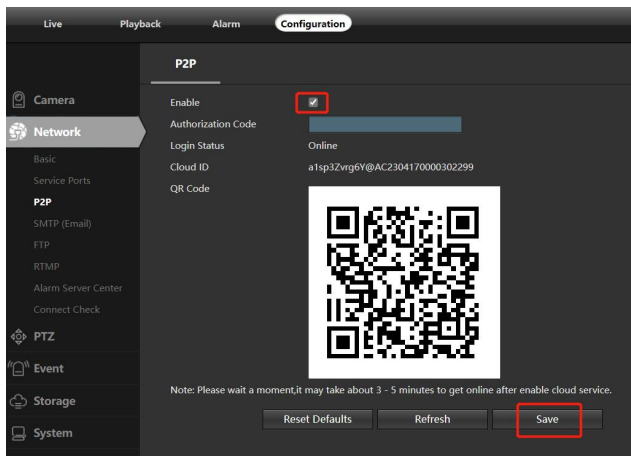

6. Tap + or **ADD NEW** and select last menu **Wired Connection** to scan the camera QR code to add the camera. (Please select the correct option depending on your device.)

7

Working with mobile device

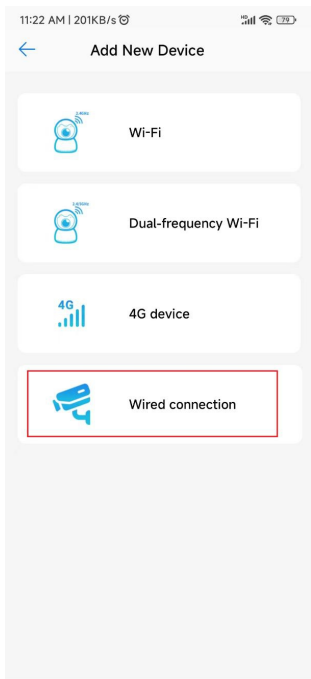
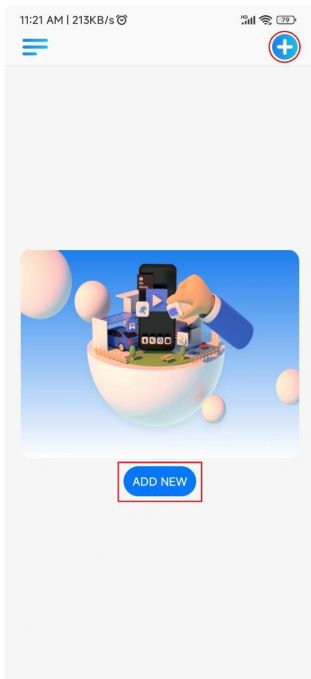

7. Tap device list to start live preview

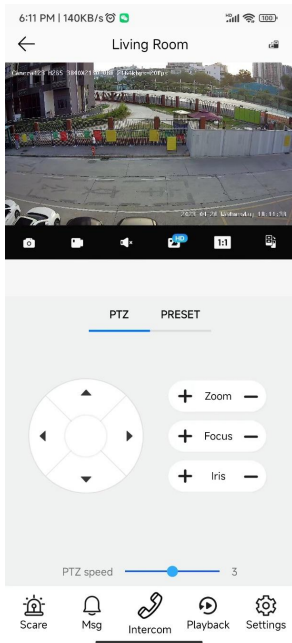

Scare: trigger camera alarm

Msg: check the event list

Intercom: start two-way audio talking

Playback: lookup the TF memory video

Settings: change camera parameters

PTZ: move or zoom the camera

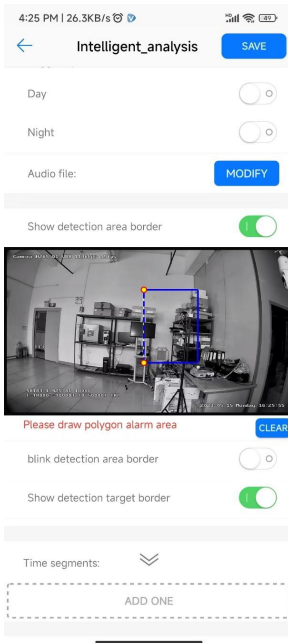

7

Working with mobile device

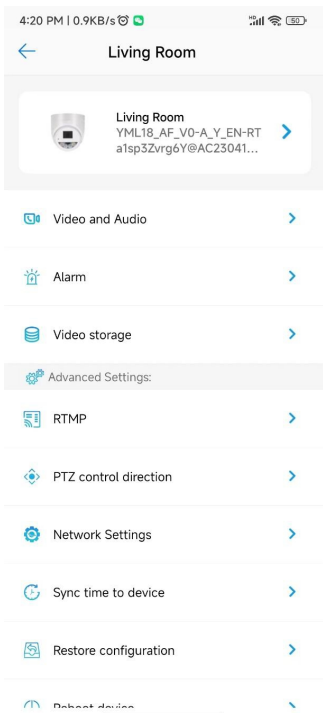
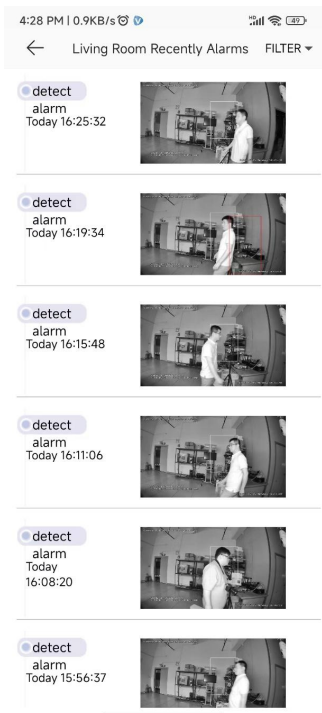

8. Share the camera to your family and friends

7

Working with mobile device

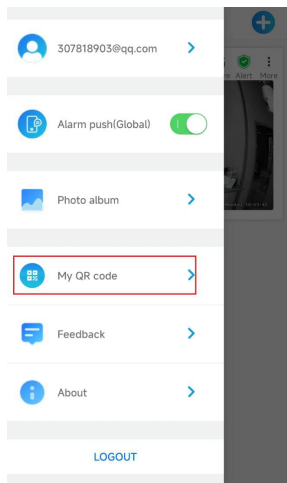
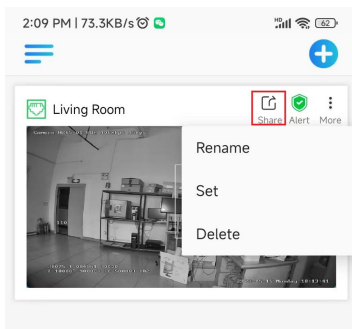

Note: if you cannot connect the camera, please check your Internet connection and verify the IP address, gateway, and DNS setting in the camera. The Cloud login status should be **online**, which means the camera has registered to the cloud server. You may also want to connect your phone to WiFi for better performance.

The IP camera supports standard ONVIF protocol and it can be added to third-party video recorder. Some of the models support both H.264 and H.265 encode mode. The H.265 encode cameras can compress the video data to a very low bit rates which allows more video data storage than normal H.264 camera. **Only configure the camera to H.265 mode when your NVR supports H.265 mode**

Before pairing cameras to the NVR, make sure the NVR and cameras have valid and matching IP scheme.

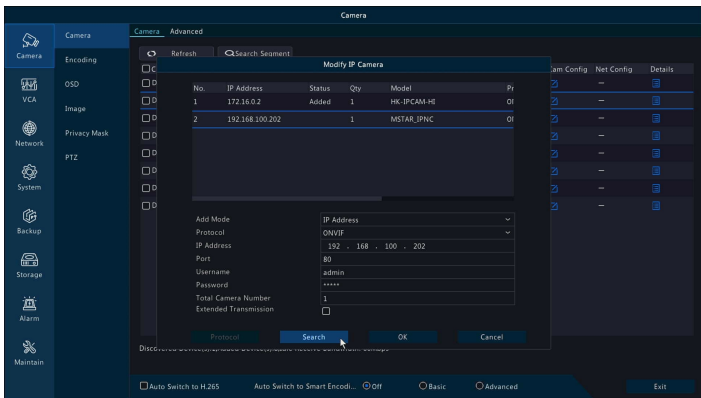

Note: Some of the PoE NVR supports **Plug & play**, which allows you to get video without manually search and add. If **Plug & play** feature is not available or not compatible, please follow the NVR manual steps and select **ONVIF** protocol as the pairing protocol. (camera default password: 123456)

If the POE NVR can not discover the connected camera or can not display the camera video, please check it's internal POE interface IP configuration and make sure all connected cameras and NVR POE interface are in the same subnet schema. For more help please contact the both NVR and IP camera suppliers for technical assistance.

Functions	Command Steps
IR MODE	SET 70, CALL 1.LED AUTO 2.LED ON 3.LED OFF
IR Sens itivity	SET 71, CALL 1-10. 1-10lux (IR open illuminance 1-10Lux)
IR Near Power	SET 72, CALL 1-10
IR Far Power	SET 73, CALL 1-10
idle function	SET 76. CALL 1.PRESET 2.SCAN 3.TOUR 4.PATTERN 5.OFF
Focus Mode	SET 77, CALL 1.AF ZOOM PUSH MODE(Focus Only When Zoom Changed) 2.AF PTZ PUSH MODE(PTZ or ZOOM will Start Focus) 3.AF AUTO MODE(Auto Mode)
Focus Distance	SET 78, CALL 1. 1M5 2. 3M 3. 6M 4.INF
Stop movement/End	Call 96
Cruising residence time	SET 75, CALL 1-255
Start Cruising	CALL 98
Set the Start Of Pattern	SET 86
Set the Stop Of Pattern	CALL 96
Start Pattern	CALL 97
Setting Scan Left border	SET 92
Setting Scan Right border	SET 93
Start Scan	CALL 99
Reset	CALL94
Factory Default	CALL82
wiper	CALL71

Functions	Command Steps
Set the Stop Of Pattern	CALL 96
Start Pattern	CALL 97
Scan Speed	SET 87, CALL 1 - 50
lens Init	SET 253, CALL 252
Auto Track Enable	CALL 89
Tracking Default Scene	SET 88
Target Lost dwell time	SET 74, CALL N (seconds), default 10s
Disable Auto Tracking	SET 96

IP PTZ Function	Command	Comments
Start SEQUENCE No.1 (Preset:1-7,5s)	Call 65	Start SEQUENCE
Start SEQUENCE No.2 (Preset:9-16,10s)	Call 66	
Start SEQUENCE No.3 (Preset:17-24,15s)	Call 67	
Start SEQUENCE No.4 (Preset:25-32,20s)	Call 68	
Start SEQUENCE No.5 (Preset:33-40,30s)	Call 69	
Start SEQUENCE No.6 (Preset:41-48,60s)	Call 70	
Start SEQUENCE No.7 (Preset:49-56,90s)	Call 72	
Start SEQUENCE No.8 (Preset:57-64,120s)	Call 73	
Stop / End Set	Call 96	
Start A-B Low Speed SCAN	Call 87	Scan A – B
Start A-B middle Speed SCAN	Call 88	
Start A-B High Speed SCAN	Call 89	
Set SCAN Right Border	Set 93	
Set SCAN Left Border	Set 92	
Stop / End Set	Call 96	
Set Guard / idle Action	Set 65+ Set pp	pp=1-7, Preset pp=11-18, Sequence (120seconds start)
StoP Guard / idle Action	Set 66	
Set Power on Action	Set 68+ Set pp	pp=1-7, Preset pp=11-18, Sequence
Set Power on Action A-B Scan	Set 70	
StoP Power on Action	Set 72	
Erase All Preset	Call 90	
Reload DEFAULT settings	Call 94	
Set Rotate Speed	Set 99+ Set pp	pp=20(Range1-64)
Enable Auto Tracking	Call 152	
Disable Auto Tracking	Set 152	

IP PTZ Function	Command	Comments
Start Sequence Patrol No.1 (Preset:1-32)	Call 41	
Start Sequence Patrol No.2 (Preset:17-32)	Call 42	
Start Sequence Patrol No.3 (Preset:65-80)	Call 43	
Start Sequence Patrol No.4 (Preset:113-182)	Call 44	
Start Sequence Patrol No.5 (Preset:129-144)	Call 45	
Start Sequence Patrol No.6 (Preset:145-160)	Call 46	
Start Sequence Patrol No.7 (Preset:161-176)	Call 47	
Start Sequence Patrol No.8 (Preset:177-192)	Call 48	
Preset dwell time: 4s	Set 51	
Preset dwell time: 6s	Set 52	
Preset dwell time: 8s	Set 53	Default
Preset dwell time: 10s	Set 54	
Preset dwell time: 12s	Set 55	
Auto Tracking: Guard Position	Set 56 or Set 92	
Auto Tracking: Max.Target Tracking time	Set 93 + Set N(N:20-255)	Default:disable
Auto Tracking: Target Lost Return time	Set 94 + Set N(N:1-255)	
Auto Tracking: Start Target Tracking	Call 56 or 92	
Auto Tracking:Start Sequence Patrol No.1 and Search Target for Tracking	Call 57 or 93	
Auto Tracking:Disable Auto Tracking	Call 58 or 94	Default:disable
Start 360°Pan Scan	Call 96 or 100	
Start A to B Scan	Call 38	
Disable A to B Scan	Set 38	
Set A-B Scan Left Position A	Set 35	
Set A-B Scan Right Position B	Set 36	
Set A-B Scan rotate speed	Set 60 to 64: 3°,6°,9°,15°,40°/sec	
Enable Idle Action	Call 105 enable	
Disable Idle Action	Set 105 disable	Default:disable

IP PTZ Function	Command	Comments
Idle Action Type	Call 101:Preset(1)	Default: 90s
	Call 102:360°pan scan	
	Call 103:A-B scan	
	Call 104:Sequence patrol No.1	
Restore Factory Settings	Call 115	
Remove All Preset	Call 33	
Init Drive System	Call 34	
IR Mode: Auto	Call 81	
IR Open	Call 82	
IR Close	Call 83	
IR Sensor: Low	Set 81	
IR Sensor: Middle	Set 82	
IR Sensor: High	Set 83	
Set IR Sensor Delay	Set 110 + Set N (N:36-100)	
Set Pan Scan Speed	Set 111 + Set N(N:1-64)	
Set Max. Control Speed	Set 113 + Set N(N:1-64)	
Set Sequence Patrol Preset dwell time	Set 114 + Set N(N:1-254)	
Set Sequence Patrol speed	Set 115 + Set N(N:1-64)	
Set Idle Action waiting time	Set 117 + Set N(N:1-254)	Default: 90s
Lens Init	Set 253 + Call 252	

1. Why can't I open the default IP address 192.168.0.123 via web browser?

Check your computer's IP address before accessing the camera. If the IP address does not match the 192.168.0.x scheme, please install the IP search tool from the CD to modify the camera's IP address. Make sure the IP address of the camera matches the LAN IP scheme. For example, if the LAN is 192.168.1.xxx, then set the IP camera to 192.168.1.123 and so on. Only IE and Firefox ESR windows computer are supported by the camera.

2. How to reset the password?

The default Username: admin, Password: 123456. If you lost the password or would to reset the camera's setting, please install the search tool to search the camera IP and click Reset factory button.

3. How to upgrade the IP camera?

- 1) Ask the supplier for the suitable firmware
- 2) you can use the web browser, search tool, or PC client to upgrade the camera
- 3) go to the Configuration > System > update, click browse and select the firmware, then click Upgrade button and wait for the operation to complete.

4. How to fetch the RTSP video stream and http snapshot?

- 1) Main Stream: rtsp://IP:554/h264?username=admin&password=123456
- 2) Sub Stream: rtsp://IP:554/h264cif?username=admin&password=123456
- 3) low resolution snapshot: http://IP/cgi-bin/snapshot.cgi?stream=1
- 4) HD snapshot : http://IP/cgi-bin/snapshot.cgi?stream=0 (only some models)

5. Why does the NVR not show image after adding your IP camera?

- 1) Make sure you selected the right protocol and enter the correct username and password when adding the cameras,
- 2) Make sure the NVR and IP camera are the same IP scheme.(eg. NVR:192.168.1.x, and IP camera:192.168.1.y),
- 3) try changing the camera encode mode to H.264 if the NVR can't support H.265.
(Configuration -> Camera -> Video > Encode mode: H.264)

6. How to make the NVR record in motion detection mode?

- 1) Enable the IP camera motion detection function via web browser or Search configure tool,
- 2) add the IP camera via ONVIF protocol,
- 3) change the NVR record mode to Motion Detection mode,
- 4) check the NVR screen MD icon and try playback. Please refer to your NVR manual for NVR motion record option.

7. Where can I control the motorized auto focus lens zoom?

- 1) Using the camera's web interface;
- 2) Control by PC client software LMS;
- 3) Roll the mouse wheel at the search tool preview window;
- 4) Find the PTZ menu in your NVR to control lens zoom.