



User Manual

HK Series
Network Turret Camera

Thank you very much for choosing ANPVIZ.

Our products are supported by the world's first video monitoring manufacturers.
and they have adopted military level of protection.

It is our top priority to ensure your data safety and offer you a satisfactory service.

We strongly recommend that you set up an appropriate password for your device and save it
also set up security questions and reserved email to ensure you can reset password by yourself.

If you have any questions, please feel free to email us at support@anpvizsecurity.com

Or visit <https://www.anpvizsecurity.com/download/>

Please download Client software and user manuals from our download center
<https://www.anpvizsecurity.com/downloadcenter.html>

■ About this Manual

The Manual includes instructions for using and managing the product. Pictures, charts, images and all other information hereinafter are for description and explanation only. The information contained in the Manual is subject to change, without notice, due to firmware updates or other reasons. Please find the latest version in the company website. Please use this user manual under the guidance of professionals.

■ Legal Disclaimer

REGARDING TO THE PRODUCT WITH INTERNET ACCESS, THE USE OF PRODUCT SHALL BE WHOLLY AT YOUR OWN RISKS. OUR COMPANY SHALL NOT TAKE ANY RESPONSIBILITIES FOR ABNORMAL OPERATION, PRIVACY LEAKAGE OR OTHER DAMAGES RESULTING FROM CYBER ATTACK, HACKER ATTACK, VIRUS INSPECTION, OR OTHER INTERNET SECURITY RISKS. HOWEVER, OUR COMPANY WILL PROVIDE TECHNICAL SUPPORT IF REQUIRED. SURVEILLANCE LAWS VARY BY JURISDICTION. PLEASE CHECK ALL RELEVANT LAWS IN YOUR JURISDICTION BEFORE USING THIS PRODUCT IN ORDER TO ENSURE THAT YOUR USE CONFORMS TO THE APPLICABLE LAW. OUR COMPANY SHALL NOT BE LIABLE IN THE EVENT THAT THIS PRODUCT IS USED WITH ILLEGITIMATE PURPOSES. IN THE EVENT OF ANY CONFLICTS BETWEEN THIS MANUAL AND THE APPLICABLE LAW, THE LATER PREVAILS.

■ Regulatory Information

FCC Information

Please take attention that changes or modification not expressly approved by the party responsible for compliance could void the user's authority to operate the equipment.

FCC compliance: This equipment has been tested and found to comply with the limits for a Class B digital device, pursuant to part 15 of the FCC Rules.

These limits are designed to provide reasonable protection against harmful interference in a residential installation. This equipment generates, uses and can radiate radio frequency energy and, if not installed and used in accordance with the instructions, may cause harmful interference to radio communications.

However, there is no guarantee that interference will not occur in a particular installation. If this equipment does cause harmful interference to radio or television reception, which can be determined by turning the equipment off and on, the user is encouraged to try to correct the interference by one or more of the following measures:

—Reorient or relocate the receiving antenna.

- Increase the separation between the equipment and receiver.
- Connect the equipment into an outlet on a circuit different from that to which the receiver is connected.
- Consult the dealer or an experienced radio/TV technician for help.

FCC Conditions

This device complies with part 15 of the FCC Rules. Operation is subject to the following two conditions:

1. This device may not cause harmful interference.
2. This device must accept any Interference received. Including Interference that may cause undesired operation

■ EU Conformity Statement



This product and - if applicable - the supplied accessories too are marked with ('CE') and comply therefore with the applicable harmonized European standards listed under the Low Voltage Directive 2015/35/EU, the EMC Directive 2014/30/EU, the RoHS Directive 2011/65/EU.



2012/19/EU (WEEE directive): Products marked with this symbol cannot be disposed of as unsorted municipal waste in the European Union. For proper recycling, return this product to your Local supplier upon the purchase of equivalent new equipment or dispose of it at designated collection points. For more information, please see: www.recyclethis.info.



2006/66/EC (battery directive): This product contains a battery that cannot be disposed of as unsorted municipal waste in the European Union. See the product documentation for specific battery information. The battery is marked with this symbol which may include lettering to indicate cadmium (Cd), lead (Pb), or mercury (Hg). For proper recycling, return the battery to your supplier or to a designated collection point. For more information, please see: www.recyclethis.info.

■ Safety Instruction

These instructions are intended to ensure that user can use the product correctly to avoid danger or property loss. The precaution measure is divided into "Warnings" and "Cautions"

Warnings: Serious Injury or death may occur if any of the warnings are neglected.

Cautions: Injury or equipment damage may occur if any of the cautions are neglected.



Warnings: Follow these safeguards to prevent serious injury or death.



Cautions: Follow these precautions to prevent potential injury or material damage.



Warnings

- Proper configuration of all passwords and other security settings is the responsibility of the installer and/or end-user.
- In the use of the product you must be in strict compliance with the electrical safety regulations of the nation and region. Please refer to technical specifications for detailed information.
- In put voltage should meet both the SELV (Safety Extra Low Voltage) and the Limited Power Source with 100~240 SC or 12 VDC according to the IEC60950-1 standard. Please refer to technical specifications for detailed information.
- Do not connect several devices to one power adapter as adapter overload may cause over-heating or a fire hazard.
- Please make sure that the plug is firmly connected to the power socket
- If smog odor or noise rise from the device, turn off the power at once and unplug the power cable, and then please contact the service center.



Cautions

- Make sure the power supply voltage is correct before using the camera.
- Do not drop the camera or subject it to physical shock,
- Do not touch sensor modules with fingers. If cleaning is necessary, use clean cloth with a bit of ethanol and wipe it gently. If the camera will not be used for an extended period, replace the lens cap to protect the sensor from dust
- Do not aim the camera at the sun or extra bright places. Blooming or smearing may occur otherwise (which is not a malfunction), and affect the endurance of sensor at the same time.
- The sensor may be burned out by a Laser beam, so when any Laser equipment is in using, make sure that the surface of sensor will not be exposed to the laser beam.

- Do not place the camera in extremely hot, cold (the operating temperature shall be -30°C to $+60^{\circ}\text{C}$, or -40°C to $+60^{\circ}\text{C}$ if the camera model has an "H1" in its suffix), dusty or damp locations, and do not expose it to high electromagnetic radiation.
- To avoid heat accumulation, good ventilation is required for operating environment.
- Keep the camera away from liquid while in use.
- While in delivery, the camera shall be packed in its original packing, or packing of the same texture.

■ 1. Appearance Description

This series of cameras have six appearances shown as the figures below.

Type I:

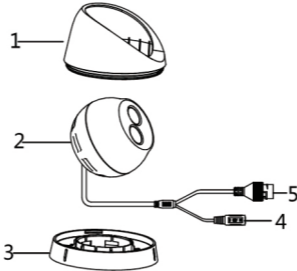

Figure 1-1 Type I Turret Camera Overview

Type II:

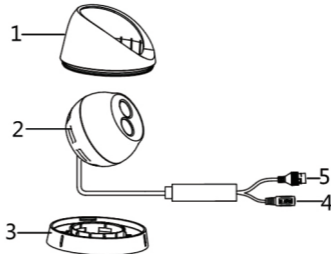

Figure 1-2 Type II Turret Camera (PoE) Overview

Type III/IV:

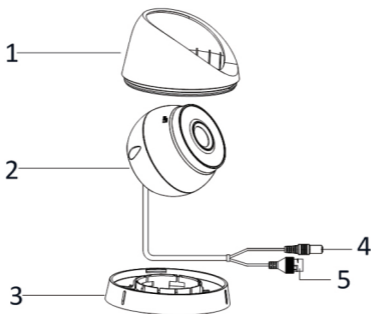

Figure 1-3 Type III/IV Turret Camera Overview

Note:

Type III and type IV cameras share the same appearance, with the difference in dimension.

Table 1-1 Description

No.	Description
1	Enclosure
2	Camera Body
3	Mounting Base
4	Power Cord
5	Network Cable

Type V:

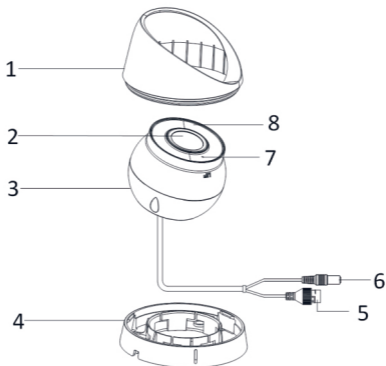

Figure 1-4 Type V Turret Camera Overview

Table 1-2 Description

No.	Description
1	Enclosure
2	Lens
3	Camera Body
4	Mounting Base
5	Network Cable
6	Power Cord
7	MIC
8	Front Cover

Type VI:

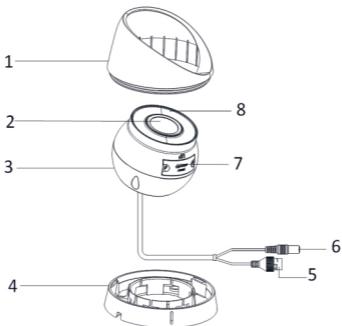

Figure 1-5 Type VI Turret Camera Overview

Table 1-3 Description

No.	Description
1	Enclosure
2	Lens
3	Camera Body
4	Mounting Base
5	Network Cable
6	Power Cord
7	Memory Card Slot Cover
8	Front Cover

Type VII:

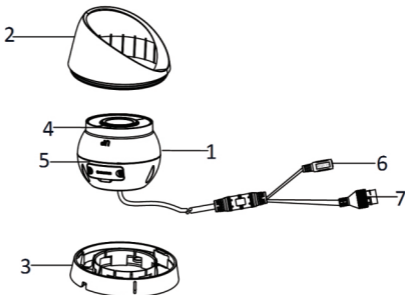

Figure 1-6 Type VII Turret Camera Overview

Table 1-4 Description

No.	Description
1	Camera Body
2	Enclosure
3	Mounting Base
4	MIC*
5	Memory Card Slot Cover*
6	Network Cable
7	Power Cord

Notes:

- The items marked with the "*" are only supported by certain camera models.
- For cameras support power over Ethernet (PoE), the power is passed along with data on Ethernet cabling. And a switch supports PoE function is required.

■ 2. Installation

Before you start:

- Make sure the device in the package is in good condition and all the assembly parts are included.
- The standard power supply is 12 VDC or PoE, make sure your power supply matches with your camera.
- Make sure all the related equipment is power-off during the installation.
- Check the specification of the products for the installation environment.
- Make sure that the wall is strong enough to withstand four times the weight of the camera and the bracket.
- Make sure that there is no reflective surface too close to the camera lens. The IR light from the camera may reflect back into the lens causing reflection.

■ 2.1 Memory Card Installation

Only certain camera models support memory card installation, you can follow the steps to mount and unmount the memory card.

Step:

1. Rotate the camera to expose the memory card slot.
2. Loosen the screws to remove the memory card slot cover.

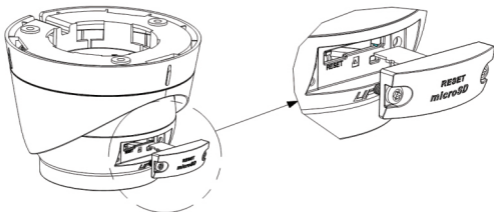

Figure 2-1 Unscrew the Cover and Insert Memory Card

1. Insert the memory card into the memory card slot.
2. (Optional) To unmount the memory card, push to get it ejected.
3. Screw the cover back to the camera.

■ 2.2 Ceiling Mounting

Before you start:

Both wall mounting and ceiling mounting are suitable for the turret camera. Ceiling mounting will be taken as an example in this section. And you can take steps of ceiling mounting as a reference for wall mounting.

This camera series shares the same installation method, we take type III/IV turret camera as the example to illustrate the installation.

Steps:

1. Paste the drill template (supplied) to the desired mounting position on the ceiling.

2. Drill the screw holes and the cable hole in the ceiling according to the drill template.

Notes:

Drill the cable hole, if adopting ceiling outlet to route the cable.

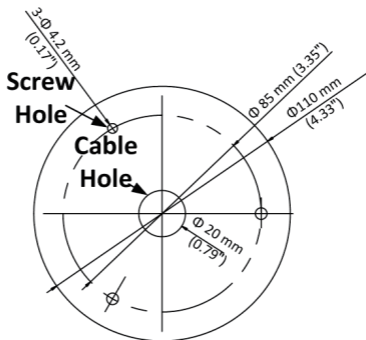

Figure 2-2 The Drill Template

3. Disassemble the camera.
 - 1). Rotate the camera to align the notch to one of the marks.
 - 2). Insert a coin or another similar tool to the notch.
 - 3). Press down the coin or another similar tool to pry the mounting base so as to separate the mounting base from the camera.

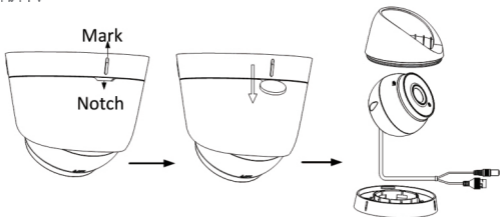

Figure 2-3 Disassemble the Camera

4. Fix the mounting base to the ceiling with supplied screws.

Notes:

- In the supplied screw package, both self-tapping screws, and expansion bolts are contained.
- If the ceiling is cement, expansion bolts are required to fix the camera. If the ceiling is wooden, self-tapping screws are required.

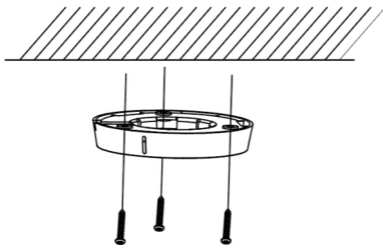

Figure 2-4 Fix the Mounting Base

5. Route the cables through the cable hole or the side opening.

6. Install the camera body back to the mounting base.

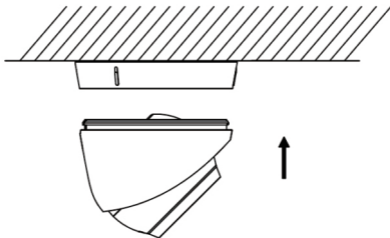

Figure 2-5 Install the Camera Body

1. Connect the power cord and network cable.
2. Power on the camera, and set the network configuration (for details, refer to) to check whether the image is gotten from the optimum angle. If not, adjust the surveillance angle.

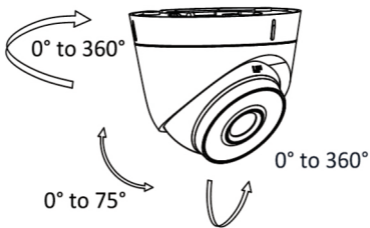

Figure 2-6 Adjust Surveillance Angle

- 1). Hold the camera body and rotate the enclosure to adjust the pan angle [0° to 360°].

- 1). Move the camera body up and down to adjust the tilt angle [0° to 75°].
- 2). Rotate the camera body to adjust the rotation angle [0° to 360°].

■ 2.3 Mounting with Junction Box

Before you start:

- You need to purchase a junction box separately if you adopt the mounting with a junction box.
- Both wall mounting and ceiling mounting are suitable for the turret camera. Wall mounting will be taken as an example in this section. And you can take steps of wall mounting as a reference for the ceiling mounting.

Steps:

1. Paste the drill template (supplied) to the desired mounting position on the wall.
2. Drill the screw holes and the cable hole in the wall according to the drill template.

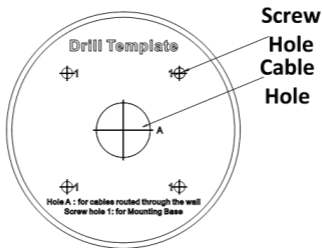

Figure 2-7 Drill Template

3. Take apart the junction box, and fix the camera's mounting base with three MP4 screws on the junction box's cover.

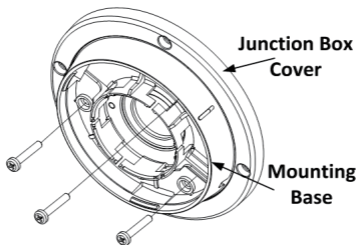

Figure 2-8 Fix screws on the junction box's Cover

4. Secure the junction box's body on the wall with four PA4 × 25 screws.

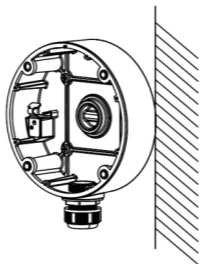

Figure 2-9 Secure the Junction Box's Body on the Ceiling/Wall

5. Combine the junction box's cover with its body with supplied screws.

6. Repeat steps 5 to 8 of 2.2 Ceiling Mounting to complete the installation.

■ 2.4 Mounting with Inclined Base

Before you start:

- You need to purchase an inclined base separately if you adopt the mounting with an inclined base.
- Both wall mounting and ceiling mounting are suitable for the turret camera. Wall mounting will be taken as an example in this section. And you can take steps of wall mounting as a reference for the ceiling mounting.
- Only certain camera models support this mounting method.

Steps:

1. Paste the drill template to the wall.
2. Drill screw holes and the cable hole (optional) on the wall according to the supplied drill template.

Notes:

Drill the cable hole, when adopting ceiling outlet to route the cable

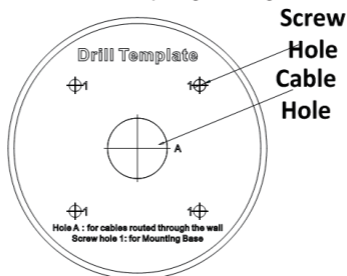

Figure 2-10 Drill Template

1. Disassemble the inclined base by the screw driver.
2. Install the turret camera's mounting base on the inclined base cover with three PM4 screws.

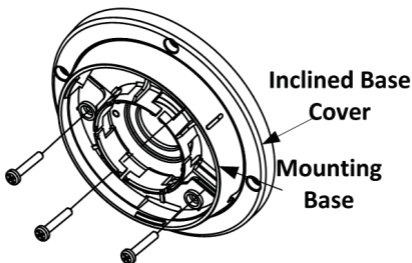

Figure 2-11 Fix Camera's Mounting Base

5. Install the inclined base's body on the ceiling/wall with four PA4×25 screws.

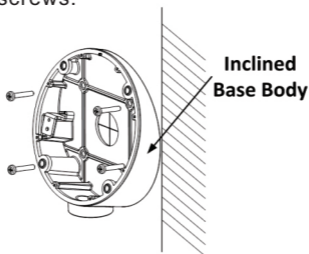

Figure 2-12 Fix the Inclined Base's boy on Ceiling/Wall

6. Combine inclined base's cover with its body with supplied screws.
7. Repeat steps 5 to 8 of 2.2 Ceiling Mounting to complete the installation.

■ 2.5 Wall Mounting

Note:

You need to purchase a wall mounting bracket separately.

Steps:

1. Drill four screw holes in the wall according to the holes of the bracket.
2. Install the bracket to the wall by aligning the four screw holes of the bracket with expansion screws on the wall.
3. Secure the bracket with four hex nuts and washers.

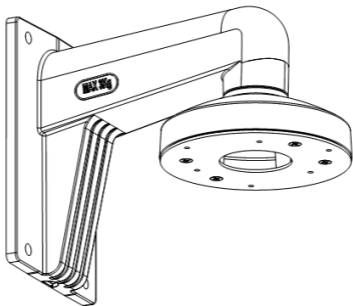

Figure 2-13 Install the Wall Mounting Bracket

4. Install the mounting base of the turret camera to the wall mounting bracket and secure them with supplied screws.

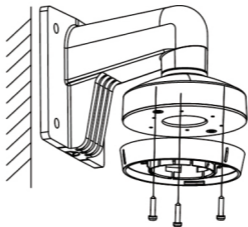

Figure 2-14 Install the Mounting Base on the Wall Mounting Bracket

5. Repeat steps 5 to 8 of 2.2 Ceiling Mounting to complete the installation.

■ 2.6 Waterproof Measures

If the camera is installed outdoor, you should use the waterproof accessory or tapes to waterproof the cables. Otherwise, the cables might get wet or a short circuit occurs.

■ 2.6.1 Install Network Cable Waterproof Jacket

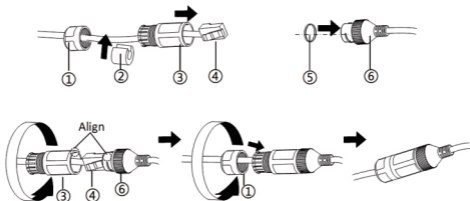

Figure 2-15 Install Waterproof Jacket

Steps:

1. Feed the network cable through ① and ③ in order.
2. Fix ② on the network cable between ① and ③.
3. Place ⑤ onto the end of ⑥, and plug the RJ45 male connector into RJ45 female connector.
4. Screw ③ to ⑥ clockwise.
5. Push ② into ③.
6. Secure ① with the ③ in clockwise direction.

■2.6.2 Waterproof Other Cables

After routing and connecting the cables, use the waterproof tapes to wrap up the cables. Connected cables and spare cables both should be wrapped up as the figures below.

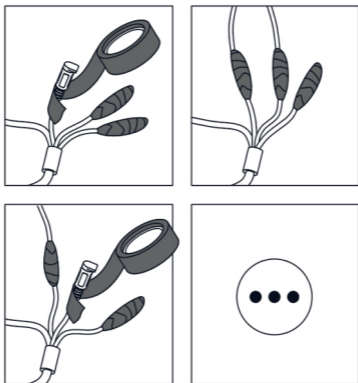

Figure 2-16 Waterproof Cables

■ 3. Activate and Access Network Camera

Scan the QR code to get Activate and Access Network Camera. Note that mobile data charges may apply if Wi-Fi is unavailable



■ 4. Operate IP Cameras via IE Browser

You can configure the IP cameras In the LAN network via the IE browser.

1.Power on the camera with a DC 12 V adapter and connect it to the same router as your computer with a network cable.

2.Install the SADP software and search the camera.

can download SADP software from our website:

<https://www.anpvizsecurity.com/software-tools-app-a00062a1.html>.

Download Center
DOWNLOAD CENTER
Home > Download Center

- ① User Start Guide
- ② Firmware
- ③ **Software/Tools/App**
- ④ Disc package file

Software/Tools/App

	Uprime series	HK Series
Search Tool	Search Tools (for Windows)	SADP (for Windows)
	Search Tools (for Mac OS)	SADP (for Mac OS 32bit)
	A/DevTools (for Windows)	SADP (for Mac OS 64bit)

3.Check the box of the camera and then activate the camera by creating a login password.

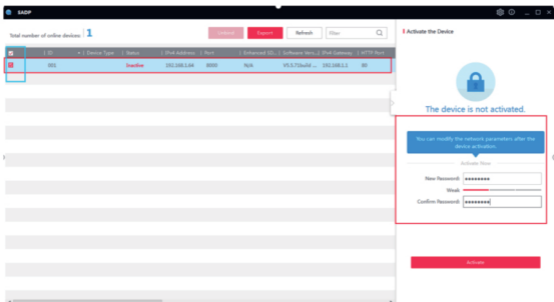

The screenshot shows the SADP software interface. On the left, there is a table with columns: ID, Device Type, Status, IP Address, Port, Enhanced ID, Software Ver., IP Address, and SADP Port. The first row is highlighted in blue and has a red checkbox checked. On the right, there is an 'Activate the Device' dialog box with a lock icon and the message 'The device is not activated.' Below this message, there are input fields for 'Activate Name', 'New Password', 'Weak', and 'Confirm Password', each with a red asterisk indicating a required field. A red 'Activate' button is at the bottom of the dialog box.

4. Double click the camera's address or you can input the IP address on the IE browser to enter the login page. The default account name is admin and the password is the one you just set up.



5. Download and install the plug-in to view live video and manage the camera. Close the browser when installing the plug-in.

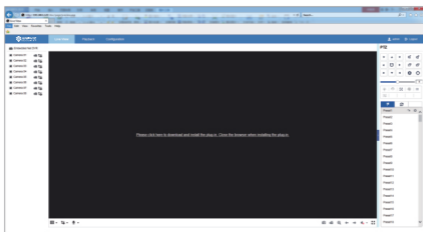

6. Re-open the IE browser and log in the camera. Choose the channel you want to access and set up the camera by clicking Configuration.

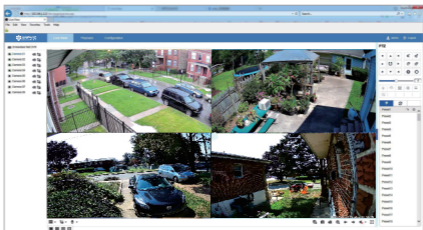



■ 5. Remote Live Stream via Smart phones

You can view the IP camera remotely via your mobile phone with the GuardingVision App.

1. Power on the camera with a DC 12 V adapter and connect it to the same router as your computer with a network cable. Make sure the router has connected to the Internet.
2. Download GuardingVision App from Google Play or Apple Store. Click Register to sign up an account with your phone number or email address. Please click Login after you have registered the account successfully.

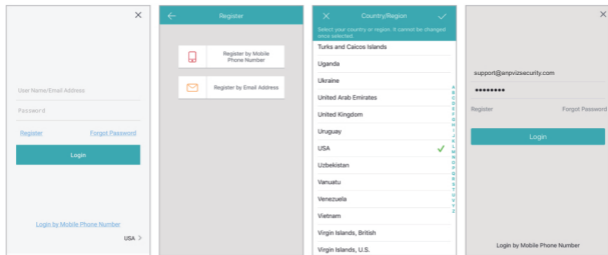
Note: Please select the correct country/region (the same location as your device) when you register an account. It cannot be changed once selected



3. Select **Add Device** , or click the icon "+" in the upper right corner to add a device. Scan the camera's QR code on the device label. Click **Next** and create a password to active the device if it has not been activated.

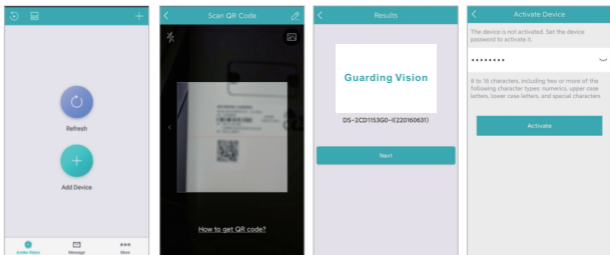



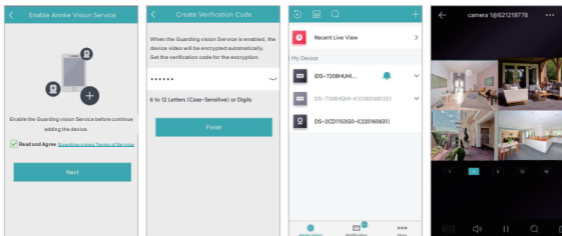



4. Click Read and Agree GuardingVision terms of service to enable GuardingVision service before continuing to add the device. Create a verification code and finish the adding process. After that, the device will be shown in the device list. Click the device name to get live view.



Note: For your security, a serial number can only be added by one account, but an account can be used on multiple mobile phones. You can share your device with others.

■ 6. Operate IP Camera via Computer Software

1. Power on the camera and connect it to the same router as your computer with a network cable.
2. Install the desktop software **Guarding Vision/IVMS 4200** and search the camera. You can download **Guarding Vision/IVMS 4200** from our website:
<https://www.anpvizsecurity.com/software-tools-app-a00062a1.html>

Software/Tools/App		
	Uprime series	HK Series
Search Tool	Search Tools (for Windows)	SACP (for Windows)
	Search Tools (for Mac OS)	SACP (for Mac OS 32bit)
	AJDevTools (for Windows)	SACP (for Mac OS 64bit)
App	  	  
PC Client	UC Client	IVMS-4200 (for Windows)
		 IVMS-4200-2.0.0.12 9uk82020423.png (for Mac)
Web Plug-in	WBCWebIlg	
Others		Hikvision Brand product App store

3. Launch Guarding Vision/IVMS 4200 software. The control panel and live view interface of Guarding Vision/IVMS 4200 are shown below.

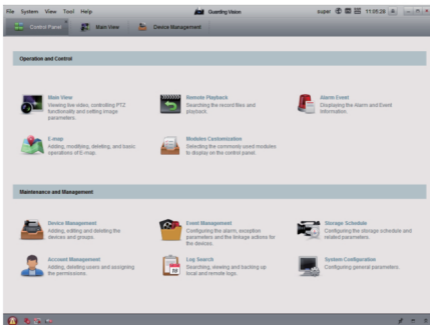

4. Go to **Control Panel-Device Management-Device**. At the bottom of the screen and in the **Online Devices** section, the screen will display all devices on the network. Create a password to activate the device if the device's status is inactive.

5. Click **Add to Client**. Input Nickname, User Name and Password (the password is the same as your activated password instead of the verification code). Click **Add** to add the device to the client software (as shown in the picture below).

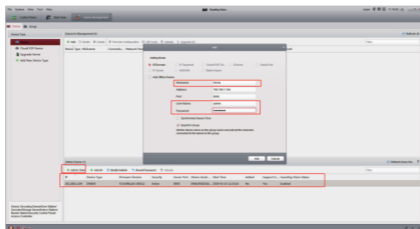

Note: If you want to access the camera remotely via the desktop software Guarding Vision, please choose **Guarding Vision/IVMS 4200 Device** and log in your cloud account to view remote live stream.

6. Go to **Control Panel-Main View**.

If you have added the IP camera, you can get a live view in the screen (as shown in the picture below).

For more information, Please press **F1** to get user manual

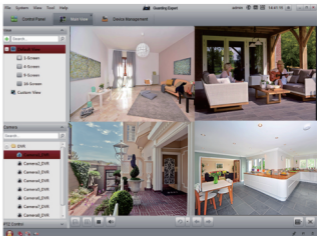

■ 7.View Live Stream with Other Software that Supports RTSP Protocol

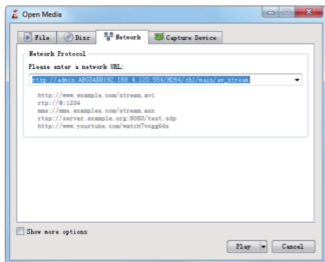

The IP camera supports RTSP protocol. The camera can be accessed via the VLC player.

Blue Iris, tinyCam and other software that supports RTSP.

The correct description of RSTP is as below:

`rtsp://[username]: [password]@[ip]: [port]/[codec]/[channel]/[subtype]/av_stream`

User name: admin (default)

Password: The password is the login password used to active your device.

IP: You can get the camera's IP address on the SADP software.

Port: 554

Codec: H264 (H.265)

Channel: ch1 (or the channel which you want to add, for example ch2)

Sub type: main (sub)

Fox example:

`rtsp://admin:qwer1234@192.168.1.64:554/H264/ch1/main/av_stream`

■ 8. Connect IP Cameras to ANPVIZ NVRs

1. Please confirm that the resolution of the IP camera is not higher than the resolution that the NVR supports.

For example, the maximum resolution that the NVR108-8P NVR supports is 8MP. You can only connect the IP camera with up to 8MP resolution.

2. Make sure the NVR is activated and can be used normally.

3. Connect the IP camera to the NVR's PoE interface with a network cable.

4. Enter the NVR menu: Main Menu -> Camera Management -> Camera -> IP Camera.

5. Click the Refresh button. If the IP camera is not activated or the activation password of the IP camera is the same as the NVR the NVR will automatically activate the IP camera and add it to the NVR channel. The status display shows that the addition is successful.

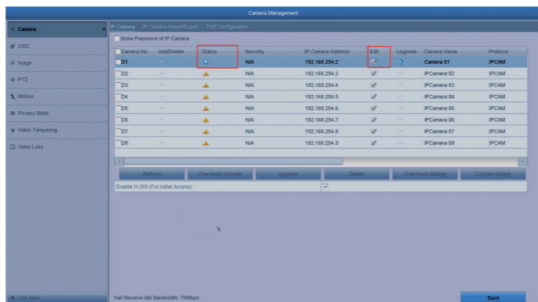

If the activation password of the IP camera is different from the NVR it is advised to modify the activation password of the IP camera and the NVR through SADP first, and then connect the NVR.

■ 9. Connect the IP Cameras to Other Brands' NVRs via ONVIF Protocol

1. Please confirm that the resolution of the IP camera is not higher than the highest resolution that the NVR supports.

2. Power on the camera and connect it to the same router as your computer with a network cable (instead of connecting the camera to the NVR's POE port).

3. Install the SADP software and then active the IP camera. Log in the camera via the IE browser.

4. After logging in the camera, please go to Configuration -> Network -> Advance Setting -> Integration Protocol.

Check the **Enable ONVIF** box. Click **Add** to create an **ONVIF account** and password. The ONVIF account and **password** will be used when you add the IP camera to the third-party NVR or DVR.

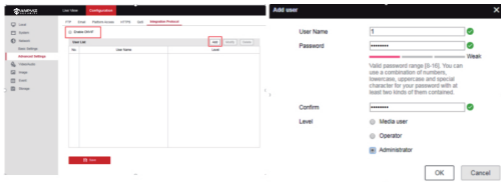

5. Add IP camera to a third-party NVR. Here we take Dahua NVR as an example. Right click the mouse to enter the main menu. Click Setting -> Remote -> Device Search to detect the camera's IP address. Select the camera and click Manual Add.



6. Input the correct ONVIF user name and password of the IP camera (instead of the login user name and password). The status will be green if the addition is successful. Click Apply and you will see the live view.



Anviz Security Electronics Co.,Ltd.
Tech Support Email Address: support@anzvizsecurity.com

Made in China

www.anpvizsecurity.com